

BELMED INC.

Nitrous Oxide/Oxygen Sedation Equipment



BELMED INC.

www.belmedinc.com

888.723.5893

Mail to:

PO Box 247
Red Lion, PA 17356-0247

Ship to:

887 Delta Rd.
Red Lion, PA 17356-0247

Contact Us:

717.246.5500
Fax: 717.246.7586
bmi@belmedinc.com

Tech Support:

help@belmedinc.com

Order:

orders@belmedinc.com

Fax: 717.246.7586

This price list is effective February 2024, and supersedes all previous price lists.

BELMED....what's in a name? **48 Years** of KNOW-HOW • 1976-2024

*Belmed understands the importance of quality products within our industry. We have consistently generated new technology to keep our customers on the cutting edge. From our **Manifold System** to our **Flowmeter**, from our **PC7-C Flushmount** to our **Defender Automatic Changeover Manifold** and **Yoke Block**, we continue to strive for excellence.*

***Belmed turns 48** in 2024 and we have proudly served the dental community with outstanding Customer Care since 1976. In 2010 we became a 100% woman-owned business, innovational in our industry. We continue to thrive and grow through leading-edge management.*

*The measure of a company is the sum of its parts, its level of quality, integrity, and customers' satisfaction. Our **MOST IMPORTANT** asset, as always, remains **YOU, OUR CUSTOMERS**. We appreciate you and look forward to working together to provide the best solutions for your needs.*

We **THANK YOU** for your loyalty.

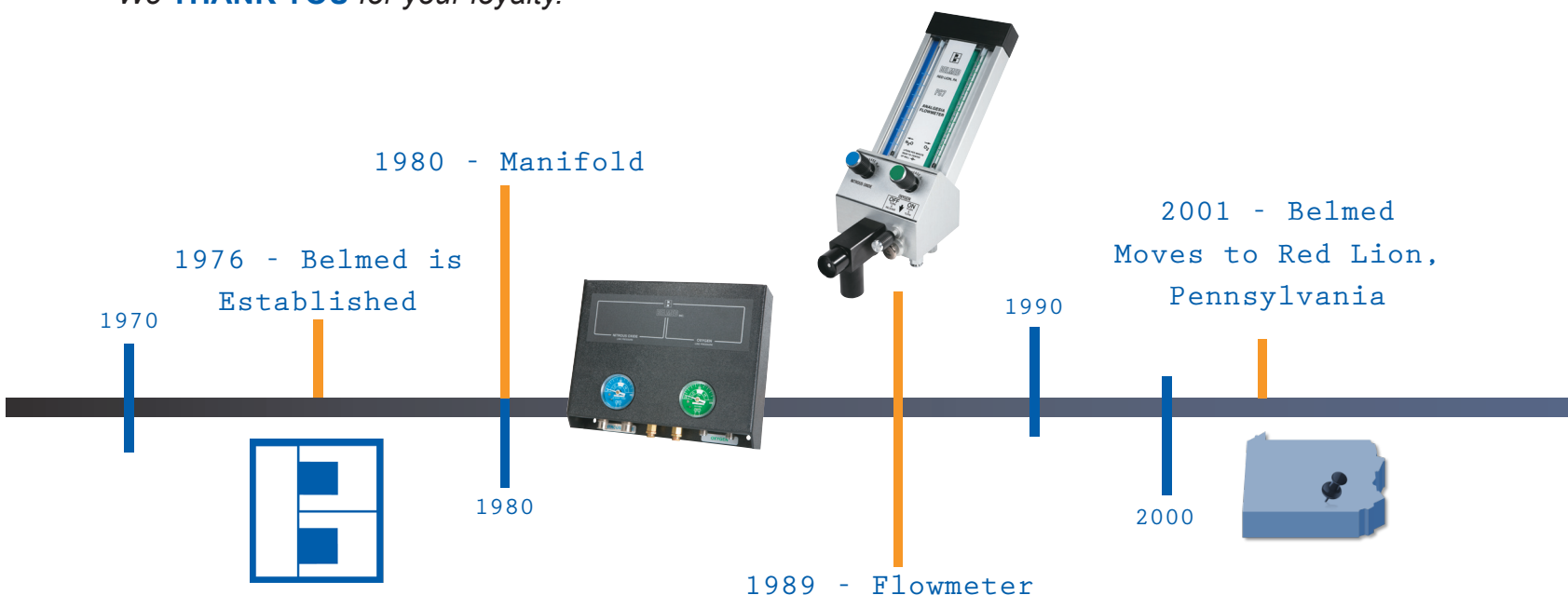

INDEX

Defender Automatic Changeover Manifold 24-25

Defender Zone Valve 25

Fittings 35

Flowmeter O2 Therapy 33

Flowmeter Oral Surgery 30

Flowmeter Stands, Mounts, Brackets, Adapters 5-7

Flowmeter Systems O2/N2O 2-4

Hoses 14-16

Manual Manifold Replacement Parts 29

Manual Manifold Systems 26-28

Nitrogen Equipment 32-33

Oral Surgery 30-33

Outlet Replacement Parts 21-23

Outlets 18-20

Policies 41

Quick Connects/Couplers 16

Ratio Flow Control 7

Regulators 34

Resuscitation Equipment 12-13

Scavenger Rubber Goods 10-11

Shut-Off Valves 17

Technical Drawings 36-39

Vacuum Collection Systems 31

Yoke Block Replacement Parts 5

Yoke Blocks O2/N2O for “E” Cylinders 5

Zone Valve 27-28

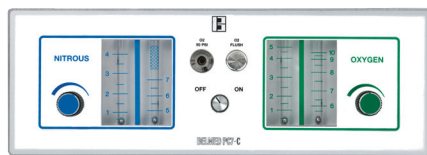

2009 - PC7-C
Flushmount Flowmeter

2010

2015 - *Defender* Automatic
Changeover Manifold



2024

2017 - New
4 Cyl
Yoke Block

PC7 FLOWMETER

Flowmeter Head Dimensions
8.75"H x 3.75"W x 10.25"D

Weight of Flowmeter Head
5 LBS

Bag and Outlet Diameter
22mm (APPROX. 7/8")

Oxygen Flow Range
3-10 LPM

Nitrous Oxide Flow Range
0-7 LPM

Fail-Safe Type
Proportional

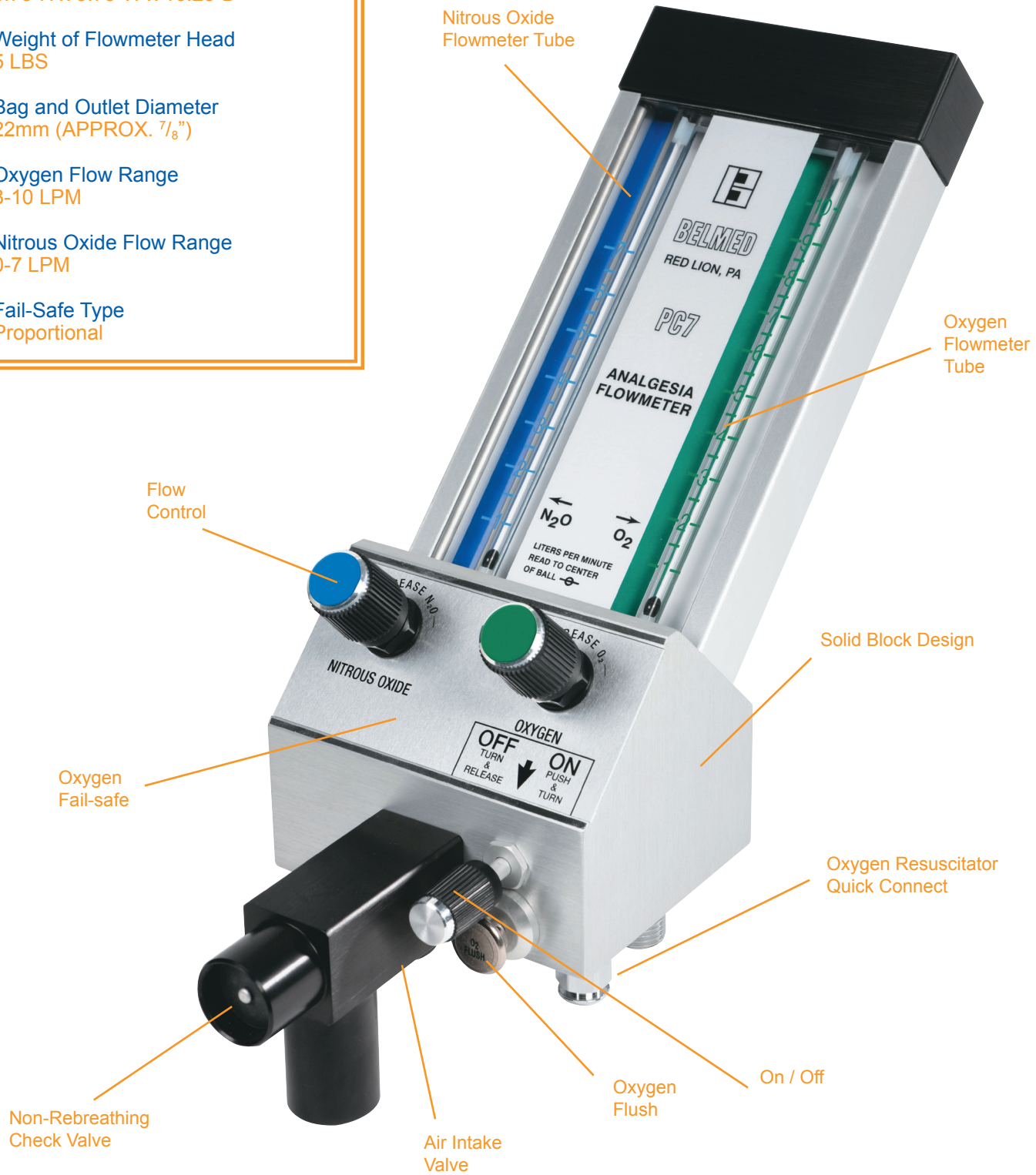

Nitrous Oxide
Flowmeter Tube

Oxygen
Flowmeter
Tube

Flow
Control

Solid Block Design

Oxygen
Fail-safe

Oxygen Resuscitator
Quick Connect

Non-Rebreathing
Check Valve

Air Intake
Valve

Oxygen
Flush

On / Off

Flowmeter Head Only PC7..... \$2,454.00

5000 Includes: Head and Mounting Adapter

NOTE: Specify Mounting Adapter. See page 7 for Mounting Adapter Options

FLOWMETER SYSTEMS

Flowmeter System with Scavenger Rubber Goods \$3,368.00

F100 Includes:
 Head, Scavenger Inhaler, Tube, Bag
 NOTE: Specify Mounting Adapter.
 See page 7 for Mounting Adapter
 Options



Flowmeter System with Short Mobile Stand \$3,740.00

F200 Includes:
 Head, Short Mobile
 Stand (Hght. 30"-40"),
 Scavenger Rubber Goods



Flowmeter System with Mobile Stand \$3,740.00

F250 Includes:
 Head, Tall Mobile
 Stand (Hght. 40"-50"),
 Scavenger Rubber Goods



Flowmeter System with 4 Cylinder Yoke Block \$6,400.00

F300 Includes:
 Head, Tall Mobile
 Stand, Scavenger
 Rubber Goods,
 4 Cylinder Yoke Block,
 DISS Hoses (2ft.)

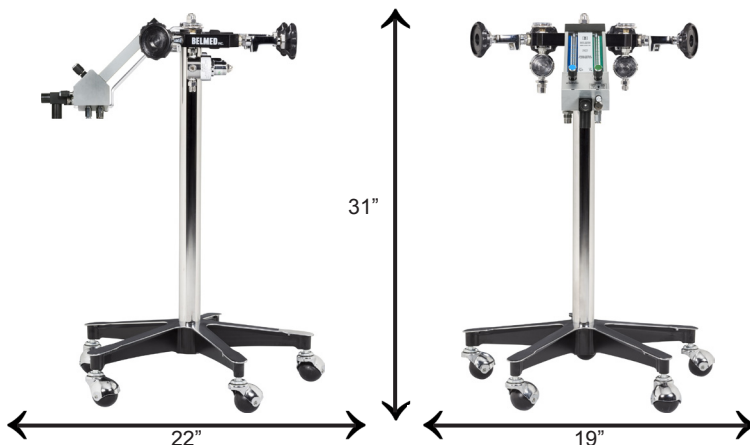

- Check valves allow two or four cylinder use
- 31" height stores effortlessly under counter tops
- Solid wheels roll easily on carpet or hard flooring
- 10" height adjustment for convenient use while sitting or standing

FLOWMETER SYSTEMS

Flowmeter System with Telescoping Arm \$3,740.00

F400 Includes:
Head, Telescoping Arm,
Scavenger
Rubber Goods



Flowmeter System with Stationary Arm \$3,740.00

F401 Includes:
Head, Stationary Arm,
Scavenger
Rubber Goods



Flowmeter System with 8" Swivel Arm \$3,740.00

F402 Includes:
Head, 8" Swivel Arm,
Scavenger
Rubber Goods



Flowmeter System with 8" Double Swivel Arm \$3,740.00

F403 Includes:
Head, 8" Double
Swivel Arm,
Scavenger
Rubber Goods



Flowmeter System with Cabinet Mount Flipout Bracket \$3,740.00

F404 Includes:
Head, Cabinet Mount
Flipout Bracket,
Scavenger
Rubber Goods



STANDS AND YOKES

Short Stand

19" High with 10" Height Adjustment

5300-1001	Belmed, Accutron PC	\$480.00
5300-1002	Fraser, MatrX	\$510.00
5300-1003	Porter, Coastal	\$510.00



Tall Stand

32" High with 10" Height Adjustment

5300-1011	Belmed, Accutron PC	\$480.00
5300-1012	Fraser, MatrX	\$510.00
5300-1013	Porter, Coastal	\$510.00

Tall Stand with 4 Cylinder Yoke Block

Includes: 24" DISS Hoses, Cylinder Wrench, Yoke Plug

	Y111	Belmed	\$3,514.00
	Y112	Fraser, MatrX	\$3,592.00
	Y113	Porter, Coastal, Accutron PC	\$3,592.00

YOKE BLOCK REPLACEMENT PARTS



5404-0000-0002
High Pressure Gauge
Oxygen \$88.00



5404-0000-0003
High Pressure Gauge
Nitrous Oxide \$88.00



5404-0000-0008
Turn Wheel Handle, Yoke \$38.00



5404-0006
Yoke Plug \$44.00



5404-0000-0018
Cylinder Wrench \$18.00



5404-0001
Cylinder Seals
Reusable Metal/Viton (Set of 4).... \$24.00



5404-0002
O2 Yoke Block Regulator..... \$324.00



5404-0003
N2O Yoke Block Regulator \$324.00

MOUNTING BRACKETS

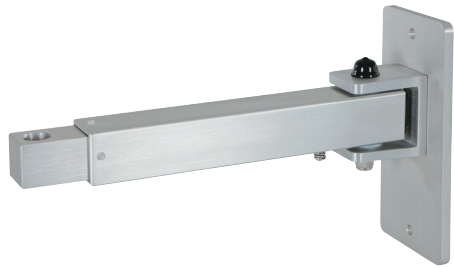

Telescoping Wall Arm

- 5200-0001** Belmed, Fraser, Matrux.....\$496.00
- 5200-0002** Porter, Coastal, Accutron PC\$506.00



Double Swivel Wall Arm

Will Fit 10" Wide Cabinet

- 5200-0021** Belmed, Fraser, Matrux..... \$496.00
- 5200-0022** Porter, Coastal, Accutron PC \$506.00

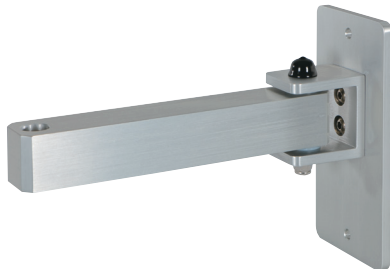

8" Swivel Arm

- 5200-0011** Belmed, Fraser, Matrux..... \$496.00
- 5200-0012** Porter, Coastal, Accutron PC \$506.00



Cabinet • Flipout Bracket

- 5200-0031** Belmed..... \$496.00
- 5200-0032** Fraser, Matrux (Top Mount Only) \$506.00
- 5200-0033** Porter, Coastal, Accutron PC \$506.00



Stationary Arm

- 5200-0041** Belmed, Fraser, Matrux.....\$372.00
- 5200-0042** Porter, Coastal, Accutron PC\$382.00



2" Post Mount

- 5200-0051** Belmed, Fraser, Matrux..... \$496.00
- 5200-0052** Porter, Coastal, Accutron PC \$506.00

MOUNTING ADAPTERS

Mobile Stand Adapter



5100-0001	Belmed Head to Belmed, Accutron PC Mobile Stand	\$66.00
5100-0002	Belmed Head to Porter, Coastal Mobile Stand	\$66.00
5100-0003	Belmed Head to Fraser, Matrx Mobile Stand	\$66.00

Arm Adapter



5100-0005	Belmed Head to Belmed Fraser, Matrx Wall Arm	\$68.00
5100-0006	Belmed Head to Porter, Accutron PC Wall Arm	\$68.00



5100-0008	Top Mount Adapter • Fraser, Matrx Top Mount Block and Stud Fraser, Matrx MDM, or RA Flowmeter	\$248.00
-----------	--	----------



5100-0000-0009	Stud • Fraser, Matrx Mounting Stud 5/8" Dia. X 3" Length RA or MDM	\$74.00
----------------	--	---------



5300-0000-0008	MS Adapter Fraser, Matrx RA, or MDM to Belmed Mobile Stand	\$74.00
----------------	--	---------

RATIO FLOW CONTROLS



5000-0100	Ratio Flow Control for PC7	\$174.00
5500-0100	Ratio Flow Control for PC7-C	\$174.00

O2 flow rate can be reduced to as low as 1 liter per minute to match patient breathing volumes while still maintaining minimum 30% O2 and 70% maximum N2O

PC7-C FLUSHMOUNT FLOWMETER

The PC7-C has been reconfigured to fit flush into today's cabinetry and provides the same time-proven precision and dependability as our standard PC-7 unit.

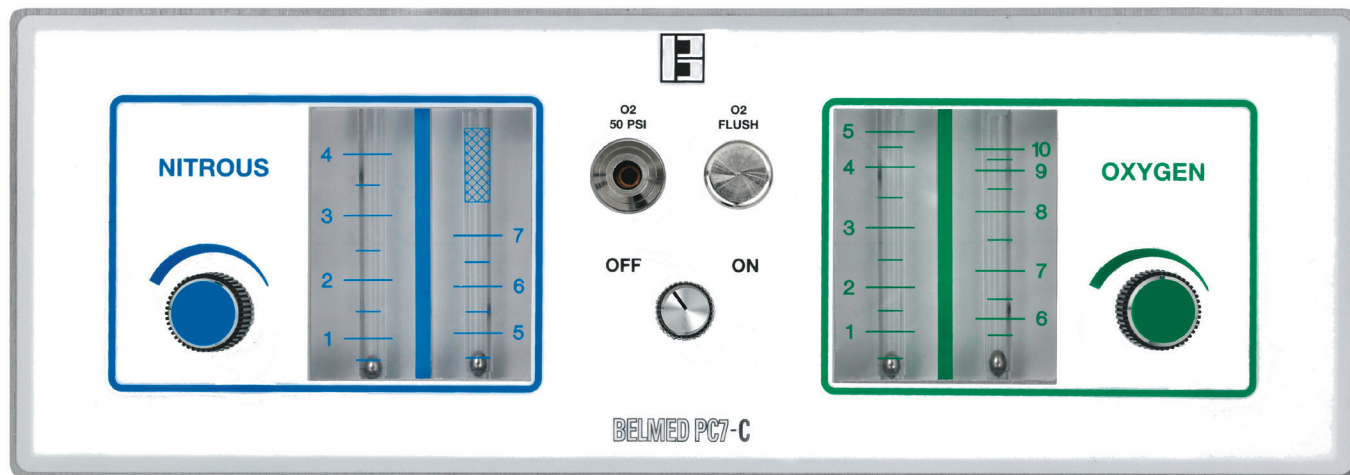

Dimensions - 4.25" H x 12.187" W x 4.687" D

- **ON/OFF CONTROL.** Simple $\frac{1}{4}$ turn, establishes a 3 liter minimum O2 flow.
- **OXYGEN FLUSH.** Provides rapid flow of oxygen directly into patient breathing circuit.
- **MICROMETER NEEDLE VALVES.** Allow quick, responsive flow adjustments. Needle valve design prevents seat damage.
- **MINIMUM 30% O2** is achieved by limiting flows to a minimum of 3 liters for O2 and a maximum of 7 liters for N2O.
- **DUAL CASCADING FLOWMETER TUBES.** O2 and N2O are calibrated in liters per minute.
- **OXYGEN FAIL-SAFE.** Automatically and proportionally reduces N2O in the event O2 is reduced or shut off.
- **SOLID GAS CONTROL BLOCK.** Designed to eliminate internal gas leaks.
- **O2 QUICK CONNECT.** Provides connection of auxiliary resuscitation equipment.
- **NRB CHECK VALVE.** Prevents the rebreathing of expired gases and guards against CO2 build-up.
- **EMERGENCY AIR VALVE.** Entrains ambient air into the breathing circuit in the event flow from the machine is lost for any reason.

FLUSHMOUNT FLOWMETER SYSTEM

Flowmeter Head Only PC7-C\$4,040.00

5500 Includes:
Flushmount Flowmeter, Remote Breathing Circuit, 10' Mixed Gas Hose

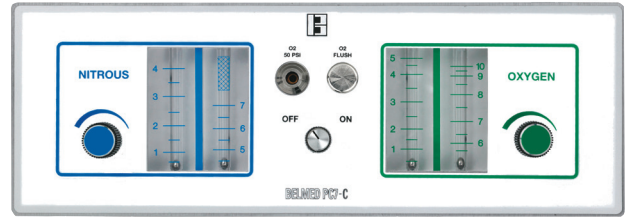







Flowmeter System PC7-C\$5,360.00

F501 Includes:
Flushmount Flowmeter, Remote Breathing Circuit, Scavenger Rubber Goods, 10' Mixed Gas Hose, 5' Supply Tubings, Risers with Check Valves for O2 and N2O



FLUSHMOUNT FLOWMETER PARTS

	5500-0009	Remote Breathing Circuit Can be Mounted Vertically or Horizontally	\$438.00
	5500-0022	Accessory Angle Top or Side Mount for Remote Breathing Circuit	\$180.00
	5500-0021	Sliding Bracket Includes: Accessory Angle Top or Side Mount – Extends Min. 12” to Max. 27”	\$352.00
	8000-3005	O2 Supply Tubing 5' Long DISS X 90° DISS (May be Ordered to Custom Lengths)	\$158.00
	8100-3005	N2O Supply Tubing 5' Long DISS X 90° DISS (May be Ordered to Custom Lengths)	\$158.00
	V100	Oxygen Riser with Check Valve	\$172.00
	V101	Nitrous Oxide Riser with Check Valve	\$172.00

SCAVENGER

Scavenger Inhaler Only..... \$820.00

- 5600-0011** with Autoclavable Small (Pedo) Hood
 - 5600-0012** with Autoclavable Medium (Adult) Hood
 - 5600-0013** with Autoclavable Large Hood
- Hoods sold separately in different sizes

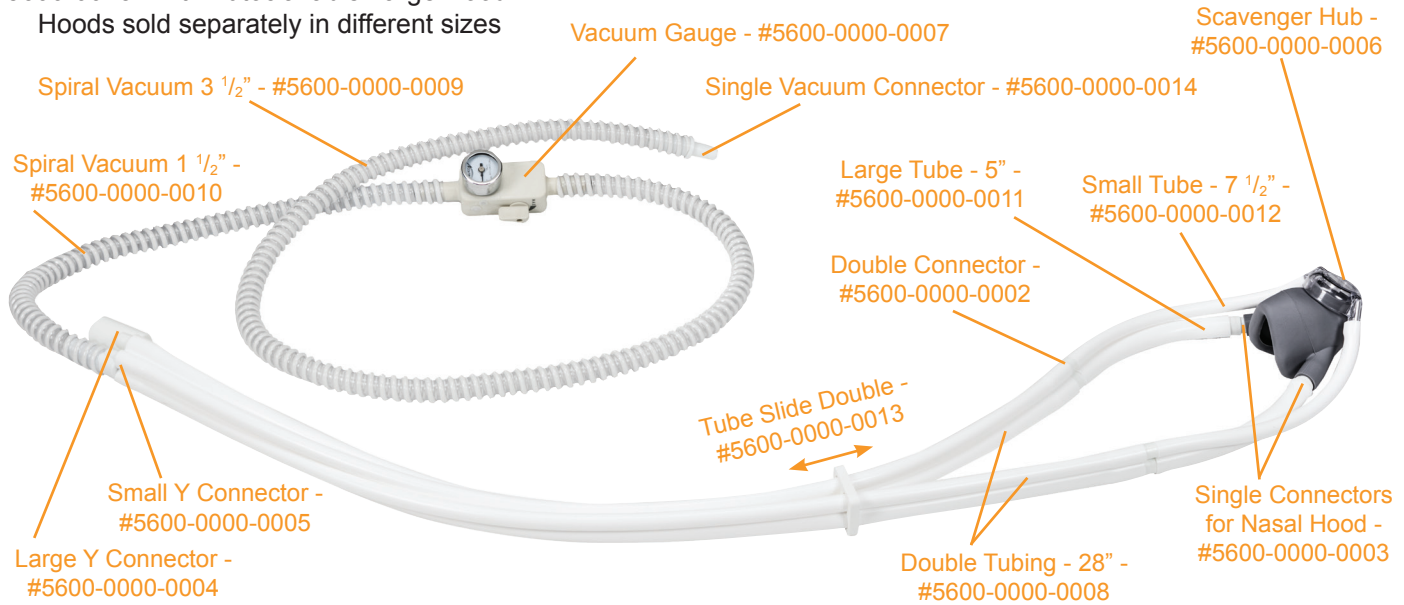



Scavenger Package..... \$876.00



- 5600-0001** Small (Pedo) Package
 - 5600-0002** Medium (Adult) Package
 - 5600-0003** Large Package
- Includes:* Scavenger Inhaler with Autoclavable Hood, (specify size: S, M, L), 3L Breathing Bag, 22mm I.D. X 32" Length Breathing Tube



RUBBER GOODS

	5600-0022	Breathing Tube 22mm I.D. X 32" Length, Corrugated	\$54.00
	5600-0023	Breathing Tube Large 22mm I.D. X 72" Length, Corrugated	\$84.00
	5600-0021	Breathing Bag 3L Neoprene	\$52.00

SCAVENGER REPLACEMENT PARTS

	5600-0000-0002	Double Connector for Scavenging Circuit (2/pkg)	\$38.00
	5600-0000-0003	Single Connector for Nasal Hood (2/pkg)	\$38.00

SCAVENGER

SCAVENGER REPLACEMENT PARTS (CONT.)

	5600-0000-0004	Large "Y" Connector for Scavenging System	\$38.00
	5600-0000-0005	Small "Y" Connector for Scavenging System	\$38.00
	5600-0000-0006	Scavenger Hub (Clear Disk)	\$60.00
	5600-0000-0007	Vacuum Gauge	\$192.00
	5600-0000-0008	Double Tubing (Order 2)	\$44.00
	5600-0000-0009	Spiral Vacuum – 3 1/2'	\$24.00
	5600-0000-0010	Spiral Vacuum – 1 1/2'	\$24.00
	5600-0000-0011	5" Large Tube (Order 2)	\$24.00
	5600-0000-0012	7 1/4" Small Tube (Order 2)	\$24.00
	5600-0000-0013	Tube Slide Double	\$38.00
	5600-0000-0014	Single Vacuum Connector	\$24.00
	5600-0000-0015	90° Elbow – 22mm I.D. X 22mm O.D.	\$31.00
	5600-0000-0016	Hood, Multi-Use Small (Pedo)	\$130.00
	5600-0000-0017	Hood, Multi-Use Medium (Adult)	\$130.00
	5600-0000-0018	Hood, Multi-Use Large	\$130.00

EMERGENCY OXYGEN EQUIPMENT

MANUAL RESUSCITATOR

Portable System \$938.00

E100 *Includes:*
 "E" Cylinder Cart, 0-15LPM Regulator,
 Manual Resuscitator, Adult Face Mask,
 Cylinder Wrench (Cylinder Not Included)



Manual Resuscitator \$282.00

9600-0000-0002 *Includes:*
 Resuscitator with Adult Face Mask



DEMAND VALVE

Portable System \$1,760.00

E200 *Includes:*
 "E" Cylinder Cart, Demand Valve,
 50psi Regulator, Child Face Mask, Adult
 Face Mask, Cylinder Wrench
 (Cylinder Not Included)



Demand Valve • Imperial \$864.00

E201 *Includes:*
 Demand Valve, 8' Hose
 with Imperial Quick Connect,
 Adult Face Mask, Child Face Mask



Demand Valve • Puritan \$864.00

E202 *Includes:*
 Demand Valve, 8' Hose
 with Puritan Quick Connect,
 Adult Face Mask, Child Face Mask



Demand Valve • Ohio \$864.00

E203 *Includes:*
 Demand Valve, 8' Hose
 with Ohio Quick Connect,
 Adult Face Mask, Child Face Mask



Demand Valve • Chemetron \$864.00

E204 *Includes:*
 Demand Valve, 8' Hose
 with Chemetron Quick Connect,
 Adult Face Mask, Child Face Mask



Demand Valve • DISS \$864.00

E205 *Includes:*
 Demand Valve, 8' Hose
 with Hand-Tight DISS Connection,
 Adult Face Mask, Child Face Mask



EMERGENCY OXYGEN EQUIPMENT REPLACEMENT PARTS



9600-0000-0001

"E" Cylinder Cart

\$214.00



9600-0000-0005

Child Face Mask
Clear with Chin Support Cup
22mm I.D. Connection

\$92.00



9600-0000-0004

Adult Face Mask
Clear with Chin Support Cup
22mm I.D. Connection

\$92.00



4900-0000-0021

Single High Pressure Gauge
50psi Pre-Set

\$518.00



4900-0000-0022

Two Gauge Adjustable
Liter Flow 0-15LPM

\$498.00



5404-0000-0018

Cylinder Wrench

\$18.00

HOSE ASSEMBLIES

Belmed can create any hose you need. Please use diagram below to create a hose to your specifications or browse through commonly used hoses on the following page.

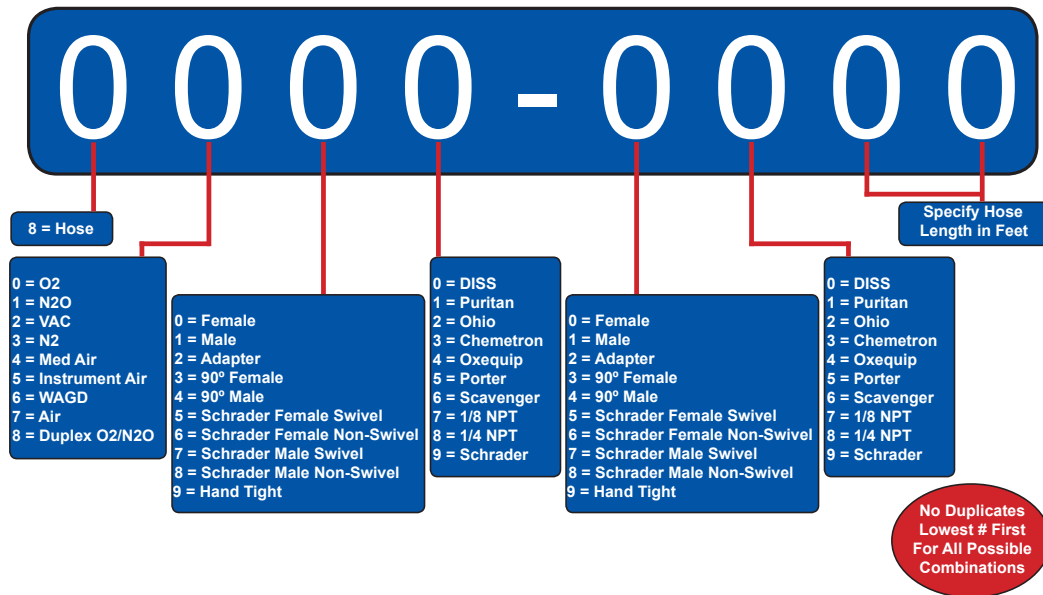

DISS Style



Oxygen



Nitrous Oxide



Vacuum



Nitrogen

MALE X FEMALE QUICK CONNECT

Puritan



Oxygen



Nitrous Oxide



Vacuum

Ohio (Matrix)



Oxygen



Nitrous Oxide



Vacuum

Chemetron (NCG)



Oxygen



Nitrous Oxide



Vacuum

Oxequip



Oxygen



Nitrous Oxide



Vacuum

Porter/Accutron

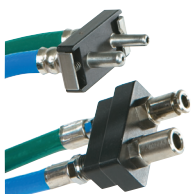

Oxygen/Nitrous Oxide Duplex

Schrader



Scavenging Adapter Kit



COMMON HOSES • 3 FT & 5 FT EXAMPLES (Any length can be made)

DISS Style DISS Nut X DISS Nut

	Common 3 FT	Common 5 FT	
Oxygen	8000-0003	8000-0005	\$144.00
Nitrous Oxide	8100-0003	8100-0005	\$144.00
Vacuum	8200-0003	8200-0005	\$144.00
Nitrogen	8300-0003	8300-0005	\$144.00

QUICK CONNECT STYLE

Male Quick Connect X DISS Nut

	Common 3 FT	Common 5 FT	
Puritan Oxygen	8000-1103	8000-1105	\$154.00
Puritan Nitrous Oxide	8100-1103	8100-1105	\$154.00
Ohio (Matrx) Oxygen	8000-1203	8000-1205	\$154.00
Ohio (Matrx) Nitrous Oxide	8100-1203	8100-1205	\$154.00
Chemetron (NCG) Oxygen	8000-1303	8000-1305	\$154.00
Chemetron (NCG) Nitrous Oxide	8100-1303	8100-1305	\$154.00
Oxequip Oxygen	8000-1403	8000-1405	\$154.00
Oxequip Nitrous Oxide	8100-1403	8100-1405	\$154.00
Porter/Accutron O2/N2O Duplex	8800-1503	8800-1505	\$304.00

Male Quick Connect X Scavenging Adapter Kit

	Common 3 FT	Common 5 FT	
Puritan Vacuum	8211-2603	8211-2605	\$154.00
Ohio (Matrx) Vacuum	8212-2603	8212-2605	\$154.00
Chemetron (NCG) Vacuum	8213-2603	8213-2605	\$154.00
Oxequip Vacuum	8214-2603	8214-2605	\$154.00

Female Quick Couplers X DISS Nut

	Common 3 FT	Common 5 FT	
Puritan Oxygen	8000-0103	8000-0105	\$252.00
Puritan Nitrous Oxide	8100-0103	8100-0105	\$252.00
Puritan Vacuum	8200-0103	8200-0105	\$252.00
Ohio (Matrx) Oxygen	8000-0203	8000-0205	\$252.00
Ohio (Matrx) Nitrous Oxide	8100-0203	8100-0205	\$252.00
Ohio (Matrx) Vacuum	8200-0203	8200-0205	\$252.00
Chemetron (NCG) Oxygen	8000-0303	8000-0305	\$252.00
Chemetron (NCG) Nitrous Oxide	8100-0303	8100-0305	\$252.00
Chemetron (NCG) Vacuum	8200-0303	8200-0305	\$252.00
Oxequip Oxygen	8000-0403	8000-0405	\$252.00
Oxequip Nitrous Oxide	8100-0403	8100-0405	\$252.00
Oxequip Vacuum	8200-0403	8200-0405	\$252.00
Porter/Accutron O2/N2O Duplex	8800-0503	8800-0505	\$466.00

Male X Female Quick Connect

	Common 3 FT	Common 5 FT	
Puritan Oxygen	8001-1103	8001-1105	\$306.00
Puritan Nitrous Oxide	8101-1103	8101-1105	\$306.00
Puritan Vacuum	8201-1103	8201-1105	\$306.00
Ohio (Matrx) Oxygen	8002-1203	8002-1205	\$306.00
Ohio (Matrx) Nitrous Oxide	8102-1203	8102-1205	\$306.00
Ohio (Matrx) Vacuum	8202-1203	8202-1205	\$306.00
Chemetron (NCG) Oxygen	8003-1303	8003-1305	\$306.00
Chemetron (NCG) Nitrous Oxide	8103-1303	8103-1305	\$306.00
Chemetron (NCG) Vacuum	8203-1303	8203-1305	\$306.00
Oxequip Oxygen	8004-1403	8004-1405	\$306.00
Oxequip Nitrous Oxide	8104-1403	8104-1405	\$306.00
Oxequip Vacuum	8204-1403	8204-1405	\$306.00
Porter/Accutron O2/N2O Duplex	8805-1503	8805-1505	\$582.00

QUICK CONNECTS/COUPLERS MALE QUICK CONNECTS X MALE DISS

Scavenger (vacuum) Connectors are Male Quick Connect x 1/4" Hose Barb



Puritan

	6002-0000-0006	Oxygen	\$114.00
	6002-0000-1005	Nitrous Oxide	\$114.00
	8200-0000-0003	Vacuum	\$114.00

Ohio (Matrx)

	6002-0000-0007	Oxygen	\$114.00
	6002-0000-1006	Nitrous Oxide	\$114.00
	8200-0000-0004	Vacuum	\$114.00

Chemetron (NCG)

	6002-0000-0008	Oxygen	\$114.00
	6002-0000-1007	Nitrous Oxide	\$114.00
	8200-0000-0005	Vacuum	\$114.00

Oxequip

	6002-0000-0023	Oxygen	\$114.00
	6002-0000-1019	Nitrous Oxide	\$114.00
	8200-0000-0008	Vacuum	\$114.00

COUPLERS ONLY X MALE 1/4 NPT



Puritan

	6002-0000-0013	Oxygen	\$188.00
	6002-0000-1012	Nitrous Oxide	\$188.00
	6002-0000-2010	Vacuum	\$188.00

Ohio (Matrx)

	6002-0000-0014	Oxygen	\$188.00
	6002-0000-1013	Nitrous Oxide	\$188.00
	6002-0000-2011	Vacuum	\$188.00

Chemetron (NCG)

	6002-0000-0015	Oxygen	\$188.00
	6002-0000-1014	Nitrous Oxide	\$188.00
	6002-0000-2012	Vacuum	\$188.00

BULK HOSE • FERRULES • CRIMPERS

Bulk Hose \$8.00/ft

8000-0000-0001	Oxygen Hose
8100-0000-0001	Nitrous Oxide Hose
8200-0000-0001	Braided Vacuum Hose
8900-0000-0001	Clear Vacuum Hose
8300-0000-0001	Nitrogen Hose



Ferrules \$2.00/each

6000-0000-0001



Crimping Tool \$144.00



6000-0000-0019



RISERS WITH CHECK VALVES

Ideal for cabinetry etc. instead of outlet stations. DISS check valve remains closed until hose is connected. Available in kits with DISS/DISS hoses and DISS hose by female quick connect couplers. NOTE: Valves with hose assemblies available in any length. Please specify length desired.

Risers with Check Valve Only • Oxygen/Nitrous Oxide

	V100	O2 Riser with Check Valve	\$172.00
	V101	N2O Riser with Check Valve	\$172.00

Note: Last two 00 in part # is length of hose. (Example: S303 is part S300 with a three foot hose.)

Risers with Check Valves with DISS X DISS Hoses

• Oxygen/Nitrous Oxide \$546.00

V200 Includes:

Set of Oxygen/Nitrous Oxide Risers with Check Valves and DISS X DISS Hoses



Risers with Check Valves and DISS X Quick Connect Coupler Hoses

• Oxygen/Nitrous Oxide \$758.00

Includes:

- V300** Set of O2/N2O Risers with Check Valves and DISS X Puritan Quick Connect Coupler Hoses (pictured)
- V400** Set of O2/N2O Risers with Check Valves and DISS X Ohio Quick Connect Coupler Hoses
- V500** Set of O2/N2O Risers with Check Valves and DISS X Chemetron Quick Connect Coupler Hoses
- V600** Set of O2/N2O Risers with Check Valves and DISS X Oxequip Quick Connect Coupler Hoses
- V700** Set of O2/N2O Risers with Check Valves and DISS X Porter/Accutron Quick Connect Coupler Hoses

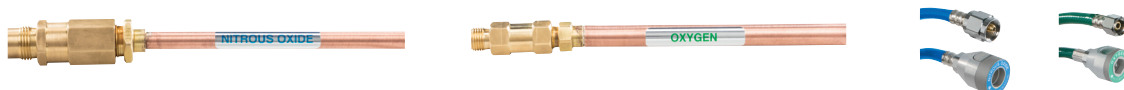

Vacuum Shut-Off Valve \$158.00

S200 Includes:

Vacuum Shut-Off Valve Assembly



Vacuum Shut-Off Valves and Assemblies \$378.00

Includes:

- S300** Vacuum Shut-Off Valve and DISS X Puritan Quick Connect Coupler Hose (pictured)
- S400** Vacuum Shut-Off Valve and DISS X Ohio Quick Connect Coupler Hose
- S500** Vacuum Shut-Off Valve and DISS X Chemetron Quick Connect Coupler Hose
- S700** Vacuum Shut-Off Valve and DISS X Porter/Accutron Quick Connect Coupler Hose
- S800** Vacuum Shut-Off Valve and DISS X Scavenger Adapter Kit Hose
- S900** Vacuum Shut-Off Valve and DISS X DISS Hose



OUTLET STATIONS QUICK CONNECT • O2/N2O/VAC



PURITAN
BELMED



OHIO/OHMEDA
MATRX



CHEMETRON (NCG)
COASTAL
EARLY PORTER



OXEQUIP
CAMBIARE
PREVIOUSLY BELMED

BELMED, PURITAN STYLE OUTLET STATION

Exploded Diagram of #9011-2213
Concealed Outlet Station

Latch assemblies also
available for Ohio (OH) and
Chemetron (CN) connectors

Latch Plate
Assembly

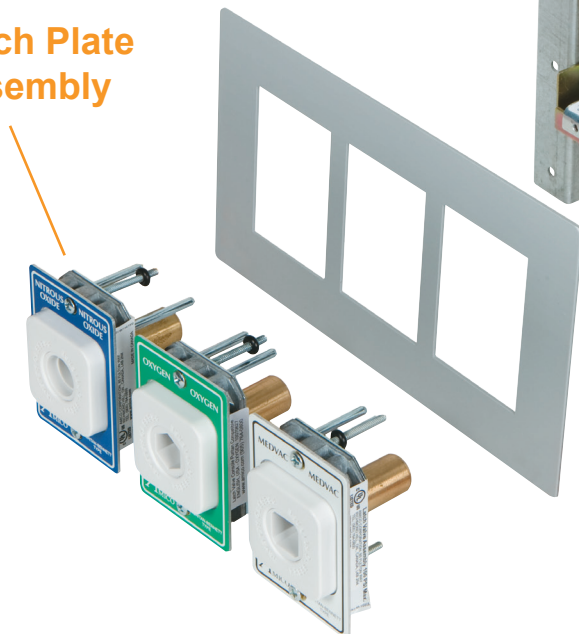

Cover Plate

N2O
O2
VAC

Pipelines
on 2 1/2"
centers

N2O always
located to
left of O2

N2O O.D.
pipe size
is 3/8" - All
others are
1/2" O.D.

Rough-In
Assembly

OUTLETS

SINGLE OUTLET • CONCEALED.....\$342.00

Nitrous Oxide

- 9011-0002 Puritan Style
- 9012-0002 Ohio Style
- 9013-0002 Chemetron

Oxygen

- 9011-0001 Puritan Style
- 9012-0001 Ohio Style
- 9013-0001 Chemetron

Vacuum

- 9011-0003 Puritan Style
- 9012-0003 Ohio Style
- 9013-0003 Chemetron



DOUBLE OUTLET • CONCEALED.....\$530.00

Nitrous Oxide/Oxygen

- 9011-1021 Puritan Style
- 9012-1021 Ohio Style
- 9013-1021 Chemetron

Oxygen/Vacuum

- 9011-1013 Puritan Style
- 9012-1013 Ohio Style
- 9013-1013 Chemetron



TRIPLE OUTLET • CONCEALED\$834.00

Nitrous Oxide/Oxygen/Vacuum

- 9011-2213 Puritan Style
- 9012-2213 Ohio Style
- 9013-2213 Chemetron



EXPOSED OUTLETS.....\$366.00

Nitrous Oxide

- 9001-0002 Puritan Style
- 9002-0002 Ohio Style
- 9003-0002 Chemetron

Oxygen

- 9001-0001 Puritan Style
- 9002-0001 Ohio Style
- 9003-0001 Chemetron

Vacuum

- 9001-0003 Puritan Style
- 9002-0003 Ohio Style
- 9003-0003 Chemetron

OUTLETS

DOUBLE OUTLET • CABINET MOUNT OUTLET CONNECTION BY DISS.....

\$558.00

Nitrous Oxide/Oxygen

- 9021-1021 Puritan Style
- 9022-1021 Ohio Style
- 9023-1021 Chemetron

Oxygen/Vacuum

- 9021-1013 Puritan Style
- 9022-1013 Ohio Style
- 9023-1013 Chemetron



TRIPLE OUTLET • CABINET MOUNT OUTLET CONNECTION BY DISS.....

\$782.00

Nitrous Oxide/Oxygen/Vacuum

- 9021-2213 Puritan Style
- 9022-2213 Ohio Style
- 9023-2213 Chemetron



OXEQUIP OUTLETS

Contact Factory for Ordering Information and Pricing



OUTLET REPLACEMENT PARTS LATCH PLATE ASSEMBLIES • CONCEALED OUTLETS\$120.00

Puritan



9000-0000-0211 Oxygen



9000-0000-0212 Nitrous Oxide



9000-0000-0213 Vacuum

Ohio



9000-0000-0221 Oxygen



9000-0000-0222 Nitrous Oxide



9000-0000-0223 Vacuum

Chemetron



9000-0000-0231 Oxygen



9000-0000-0232 Nitrous Oxide



9000-0000-0233 Vacuum

DISS



9000-0000-0201 Oxygen



9000-0000-0202 Nitrous Oxide



9000-0000-0203 Vacuum



9000-0000-0204 Nitrogen

LATCH PLATE ASSEMBLIES • EXPOSED OUTLETS\$120.00

Puritan



9000-0000-0111 Oxygen



9000-0000-0112 Nitrous Oxide



9000-0000-0113 Vacuum

Ohio



9000-0000-0121 Oxygen



9000-0000-0122 Nitrous Oxide



9000-0000-0123 Vacuum

Chemetron



9000-0000-0131 Oxygen



9000-0000-0132 Nitrous Oxide



9000-0000-0133 Vacuum

Super 6 Special!

Buy 6 "complete" systems and receive an entire system FREE!*

*Scavenger package not included with free unit.

Systems included: F100, F200, F250, F300, F400, F401, F402, F403, F404, M100, M101, M105, M160, M161, M165

Contact Belmed for full details.



OUTLET REPLACEMENT PARTS

ROUGH-IN ASSEMBLIES • CONCEALED

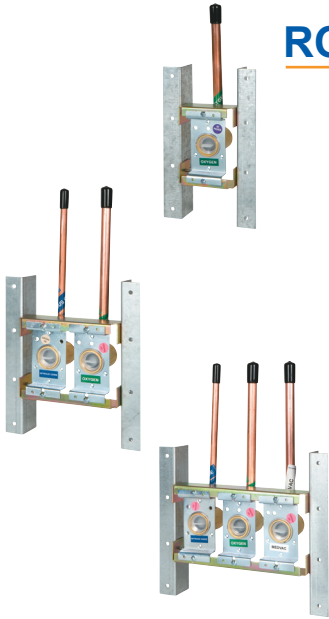

9000-0000-0001	Single Outlet Oxygen	\$198.00
9000-0000-0002	Nitrous Oxide	\$198.00
9000-0000-0003	Vacuum	\$198.00
9000-0000-0011	Double Outlet Oxygen	\$356.00
9000-0000-0012	Nitrous Oxide	\$356.00
9000-0000-0021	Triple Outlet	\$490.00

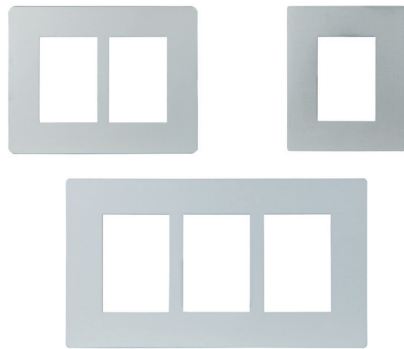

COVER PLATES

9000-0000-0041	Single, Concealed	\$46.00
9000-0000-0042	Double, Concealed	\$56.00
9000-0000-0043	Triple, Concealed	\$66.00

EXPOSED OUTLET BOX

9000-0000-0044	Exposed Single Box	\$142.00
----------------	--------------------	----------



OUTLET PARTS • PURITAN, OHIO, CHEMETRON



9000-0000-0051	Rough-In Repair Kit	\$86.00
----------------	---------------------	---------



9000-0000-0052	PURITAN All Gas Latch Plate Repair Kit	\$86.00
----------------	--	---------

9000-0000-0053	OHIO or CHEMETRON All Gas Latch Plate Repair Kit	\$86.00
----------------	--	---------

OUTLET REPLACEMENT PARTS

OUTLET PARTS • OXEQUIP

	9100-0000-0021	Rebuild Kit • Vacuum	\$98.00
	9100-0000-0020	Rebuild Kit • All Gases (Except Vacuum)	\$98.00
	9100-0000-0017	Tumbler • Oxygen	\$98.00
	9100-0000-0018	Tumbler • Nitrous Oxide	\$98.00
	9100-0000-0019	Tumbler • Vacuum	\$98.00
	9100-0000-0016	Cam Plate	\$98.00
	9100-0000-0012	Mounting Ring	\$98.00
	9100-0000-0022	Seat Seals (6/pk)	\$98.00

COVER PLATES • OXEQUIP

	9100-0000-0004	Cover Plate • Single • Concealed	\$55.00
	9100-0000-0005	Cover Plate • Double • Concealed	\$75.00
	9100-0000-0006	Cover Plate • Triple • Concealed	\$95.00

Defender AUTOMATIC CHANGEOVER MANIFOLD

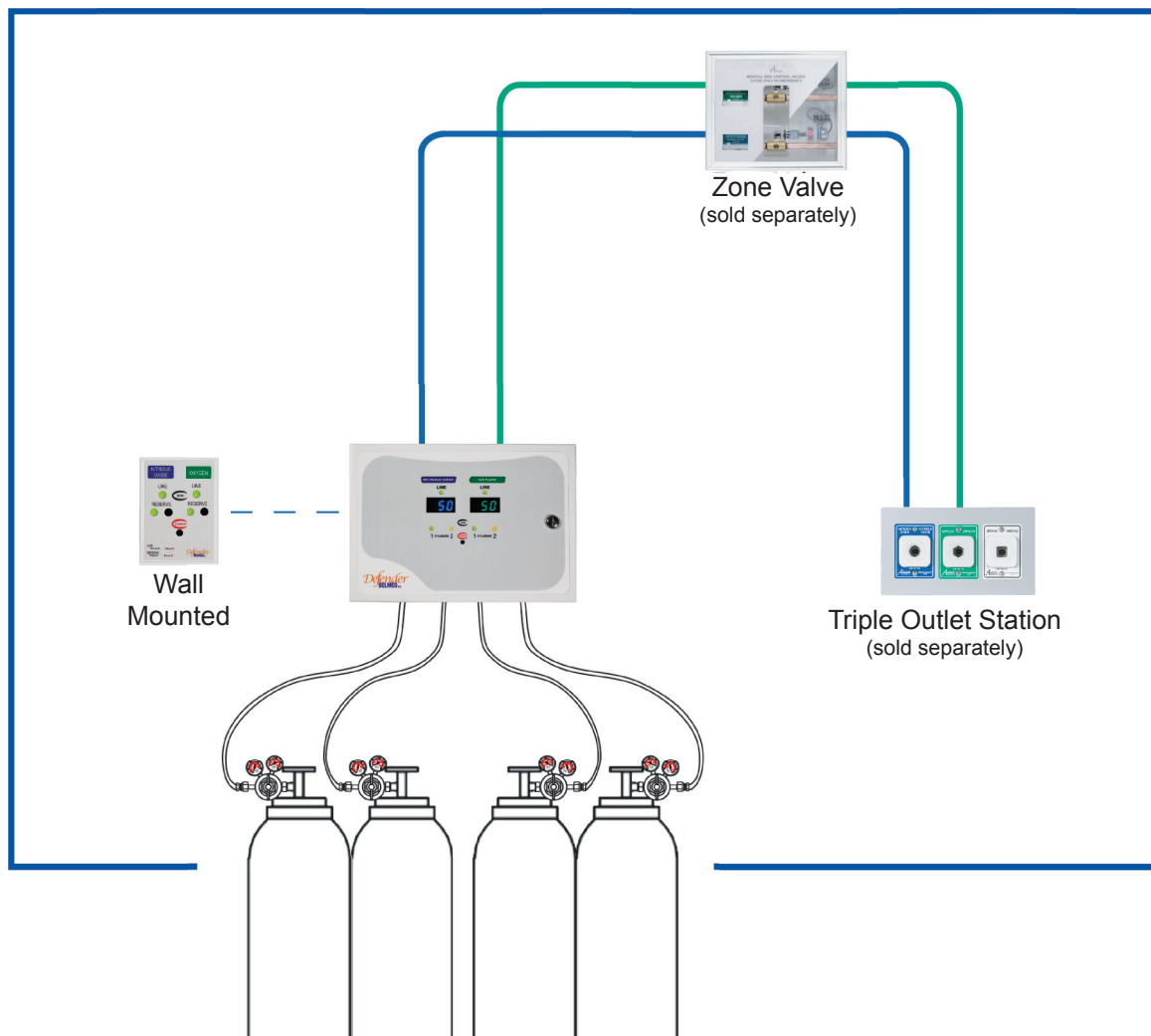

The Belmed *Defender* Automatic Changeover Manifold is the perfect manifold solution for your dental nitrous oxide delivery system. The *Defender* can accommodate two cylinders for both oxygen and nitrous oxide. This manifold is fully automatic and will switch from “In-Use” to “Reserve” tank without fluctuations in the gas delivery. The “Empty” indicator will remain lit until a new cylinder is connected and the appropriate pressure is detected by the manifold. The system is auto-sensing...no need to manually reset the manifold after a cylinder change.

- Easy to read LED display clearly shows gas pressures and cylinder status
- Automatic detection of cylinder pressure, no manual reset is required
- Medical grade sensors that give you the reliability you need
- Integrated Dry Contacts for additional remote monitoring
- Complies with NFPA 99

Defender AUTOMATIC CHANGEOVER MANIFOLD SYSTEMS



Defender Automatic Changeover Manifold System

with Alarm & Pre-Install Kit\$6,986.00

A100 Manifold System with Wall Alarm & Pre-Install Kit

Includes: Automatic Changeover Manifold, Alarm, Regulators, Hoses, Tank Restraints, and Pre-Install Kit

Defender Automatic Changeover Manifold System with Alarm\$6,698.00

A120 Manifold System with Wall Alarm

Includes: Automatic Changeover Manifold, Alarm, Regulators, Hoses, and Tank Restraints



Defender Pre-Install Kit\$288.00

A130 *Includes:* Pipeline Connectors, Cable, and Gas Identification Labels

Defender Zone Valve Shut-Off\$2,030.00

A150 *Includes:* Zone Valve for Defender Automatic Changeover Manifold and Cable

ADDITIONAL ACCESSORIES



7100
Defender O2 Pipeline Connector \$102.00



7120
Defender N2O Pipeline Connector \$102.00



6000-0000-1003
O2 Gas Identification Label (6/pk) \$16.00

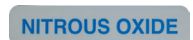

6000-0000-1004
N2O Gas Identification Label (6/pk) \$16.00



4024-0000-0011
Transformer 12VAC \$104.00



4024-0000-0012
Defender Cable (100') \$110.00



4054-0000-0001
Defender Zone Valve Cable \$4.00/ft



4022-0000-0050
Tank Restraint Holds two G/H Size Cylinders \$140.00

MANUAL MANIFOLD SYSTEM

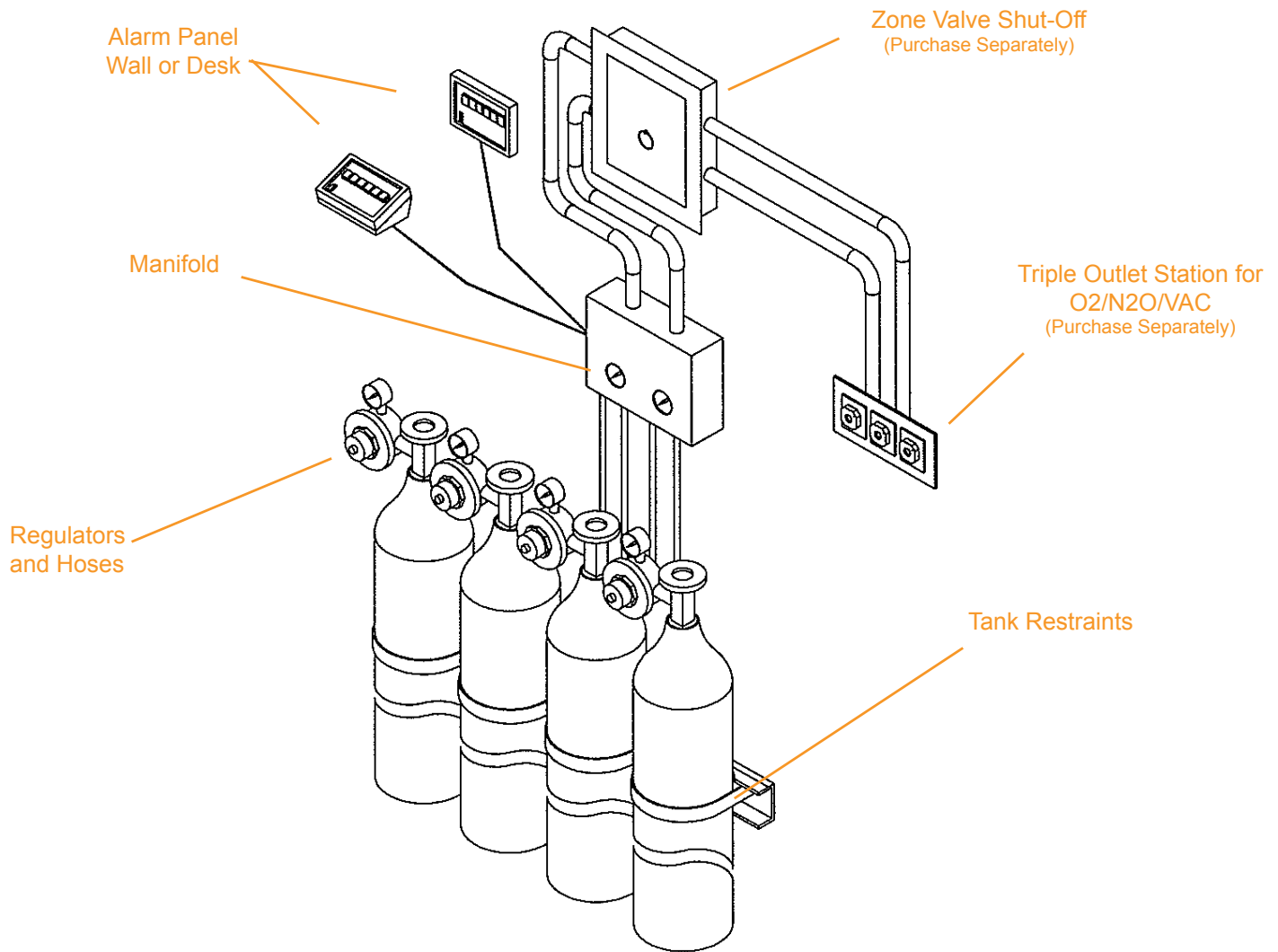

<p>Manifold System Dimensions 11.5"H x 9.25"W x 3"D</p>	<p>Hose Length 48"</p>	<p>Primary Voltage to Alarm 12 VAC</p>
<p>Alarm Size Wall • 5"H x 7"W x 0.75"D Desk • 5"H x 7"W x 4"D</p>	<p>Outlet Line Size Oxygen: 1/2" OD Copper Nitrous Oxide: 3/8" OD Copper</p>	<p>Wire Manifold to Alarm: 50' • 5 Conductor/22 GA. Plenum Transformer to Alarm: 30' • 2 Conductor/22 GA. Plenum</p>
<p>Relief Valve Pressure 75 PSI</p>	<p>Low Pressure Alarm Point 40 PSI</p>	<p>Fuse 5mm X 20mm - 0.5 AMP</p>
<p>Normal Working Pressure 50-55 PSI</p>	<p>High Pressure Alarm Point 65 PSI</p>	<p>NFPA 99 Category 3 Compliant</p>
<p>Maximum Hose Pressure 250 PSI (1000 PSI BURST)</p>		

MANUAL MANIFOLD SYSTEMS • O2/N2O COMPLETE SYSTEMS



Manual Manifold System with Alarm & Pre-Install Kit.....\$4,940.00

- M100** Manifold System with Wall Alarm & Pre-Install Kit
- M101** Manifold System with Wall Alarm & Pre-Install Kit (Existing Wall)
- M105** Manifold System with Desk Alarm & Pre-Install Kit
Includes: Manifold, Alarm, Cables, Regulators, Hoses, Tank Restraints, and Pre-Install Kit

Manual Manifold System with Alarm.....\$4,712.00

- M120** Manifold System with Wall Alarm
- M125** Manifold System with Desk Alarm
Includes: Manifold, Alarm, Cables, Regulators, Hoses, and Tank Restraints



Manual Manifold Pre-Install Kit\$228.00

- M130** Wall
- M131** Wall (Existing Wall)
- M135** Desk
Includes: Pipeline Connectors, necessary cables and alarm mounting arrangement for wall or desk style alarm

Manual Manifold Zone Valve Shut-Off.....\$1,620.00

- M150** *Includes:* Frangible Cover, O2/N2O ¼ Turn Shut-Offs, Alarm Pressure Switches
Dimensions: 15”H x 12”W x 4”D
*Designed for recessed installation, but may be surface mounted

COMPONENTS



Manifold Only.....\$2,630.00

- 4022** 2 Oxygen / 2 Nitrous Oxide Cylinder(s) Manifold



Wall Alarm Kit\$1,200.00

- M110** Wall • *Includes:* Alarm, Transformer, Cables
- M111** Existing Wall • *Includes:* Alarm, Transformer, Cables



Desk Alarm Kit.....\$1,200.00

- M115** Desk • *Includes:* Alarm, Transformer, Cable, Pressure switches

MANUAL OXYGEN MANIFOLD SYSTEMS



2 Oxygen Cylinder Manifold System with Alarm & Pre-Install Kit \$3,824.00

- M160** Oxygen Manifold System with Wall Alarm & Pre-Install Kit
- M161** Oxygen Manifold System with Wall Alarm & Pre-Install Kit (Existing wall)
- M165** Oxygen Manifold System with Desk Alarm & Pre-Install Kit
Includes: Manifold, Alarm, Transformer, Regulators, Hoses, Tank restraints, & Pre-install kit

2 Oxygen Cylinder Manifold System with Alarm \$3,594.00

- M180** Oxygen Manifold System with Wall Alarm
- M181** Oxygen Manifold System with Wall Alarm (Existing wall)
- M185** Oxygen Manifold System with Desk Alarm
Includes: Manifold, Alarm, Transformer, Regulators, Hoses, & Tank restraints



2 Oxygen Cylinder Manifold Pre-Install Kit \$230.00

- M190** Wall
- M191** Wall (Existing Wall)
- M195** Desk
Includes: Pipeline connectors, necessary cable, and alarm mounting arrangement for wall or desk alarm

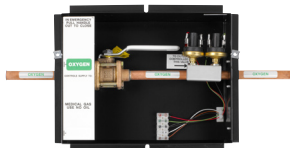

2 Oxygen Cylinder Manifold Zone Valve Shut-Off \$1,500.00

- M155** *Includes:* Frangible cover, O2 1/4 Turn Shut-Offs, Alarm Pressure Switches
*Designed for recessed installation, but may be surface mounted

COMPONENTS



2 Oxygen Cylinder Manifold \$1,912.00
4020 Oxygen Manifold • 2 Cylinders



Oxygen Wall Alarm Kit \$1,220.00
M170 Wall • *Includes:* Alarm, Transformer, Cables
M171 Existing Wall • *Includes:* Alarm, Transformer, Cables



Oxygen Desk Alarm Kit \$1,220.00
M175 *Includes:* Alarm, Transformer, Cables

MANIFOLD SYSTEM REPLACEMENT PARTS

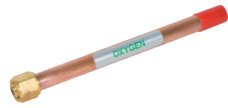

4022-0003
 Oxygen Pipeline Connector
 O2 DISS Nut X 1/2"
 O.D. Tube (6" Length)
 \$84.00



4022-0004
 Nitrous Oxide Pipeline Connector
 N2O DISS Nut X 3/8"
 O.D. Tube (6" Length)
 \$84.00



4022-0000-0005
 Oxygen Gauge 2" Diameter
 Male 1/4" NPT C.B. Connection
 \$84.00



4022-0000-0006
 Nitrous Oxide Gauge 2" Diameter
 Male 1/4" NPT C.B. Connection
 \$84.00



4022-0000-0007
 Relief Valve Preset
 75psi for Oxygen
 or Nitrous Oxide
 \$84.00



4022-0000-0050
 Tank Restraint
 Holds two G/H Size Cylinders
 \$140.00



6000-0000-3006
 Cable, 5 Conductor
 Manifold to Wall Alarm,
 Plenum Wall/Desk
 \$3.00/Ft



6000-0000-3008
 Cable, 2 Conductor
 Transformer to Alarm, Plenum
 \$3.00/Ft

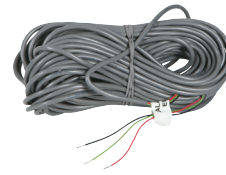

6000-0000-3007
 Cable, 3 Conductor
 Manifold to Alarm
 (Oxygen Only Manifold), Plenum
 \$3.00/Ft

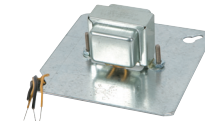

3000-0003
 Transformer
 Wall-Style Alarm
 12VAC
 \$94.00



3050-0000-0003
 Transformer
 Desk-Style Alarm
 12VAC
 \$94.00



3000-0006
 Universal Alarm Bulbs
 6/pk
 \$38.00



6002-0000-0003
 Manifold Check Valve
 Oxygen Male 1/8"
 NPT X O2 Male DISS
 \$58.00



6002-0000-1002
 Manifold Check Valve
 Nitrous Oxide Male 1/4"
 NPT X N2O Male DISS
 \$58.00



4022-0000-0004
 Pressure Switch High 65psi
 (Specify Gas)
 \$132.00

4022-0000-0003
 Pressure Switch Low 40psi
 (Specify Gas)
 \$132.00

ORAL SURGERY PACKAGES

Oral Surgery Flowmeter System with 4 Cylinder Yoke Block\$7,482.00

F900 Includes: PC-7 Head, Scavenger Rubber Goods, "Y" Selector Valve Package, Tall Mobile Stand, 4 Cylinder Yoke Block, DISS Hoses (2')



Oral Surgery Flowmeter System with Telescoping Arm\$4,874.00

F901 Includes: PC-7 Head, Scavenger Rubber Goods, "Y" Selector Valve Package, Telescoping Arm







Flowmeter "Y" Selector Valve Package\$1,292.00

F950 Includes: "Y" Selector Valve, Breathing Tube, Non-Rebreathing Valve, Child Full Face Mask, Adult Full Face Mask



COMPONENTS • "Y" SELECTOR VALVE

	9650-0000-0001	"Y" Selector Valve Connection: 22mm O.D. • Ports: 22mm O.D. X 15mm I.D.	\$842.00
	9650-0000-0002	Non-Rebreathing Valve Positive Pressure Thumb Button Adjustable Relief Valve 90°	\$306.00
	9600-0000-0005	Child Face Mask Clear with Chin Support Cup • 22mm I.D. Connection	\$92.00
	9600-0000-0004	Adult Face Mask Clear with Chin Support Cup • 22mm I.D. Connection	\$92.00
	5600-0022	Breathing Tube 22mm I.D. X 32" Length, Corrugated	\$54.00

ORAL SURGERY SURGICAL SUCTION VACUUM COLLECTION UNITS

	S100	PURITAN <i>Includes: Vacuum Regulator, 6' Clear Vacuum Tubing, Wall Plate, Canister Holder, Six 1500ml Single-Use Canisters</i>	\$1,008.00
	S101	OHIO <i>Includes: Vacuum Regulator, 6' Clear Vacuum Tubing, Wall Plate, Canister Holder, Six 1500ml Single-Use Canisters</i>	\$1,008.00
	S102	CHEMETRON <i>Includes: Vacuum Regulator, 6' Clear Vacuum Tubing, Wall Plate, Canister Holder, Six 1500ml Single-Use Canisters</i>	\$1,008.00
	S103	OXEQUIP <i>Includes: Vacuum Regulator, 6' Clear Vacuum Tubing, Wall Plate, Canister Holder, Six 1500ml Single-Use Canisters</i>	\$1,008.00
	9500-0001	PURITAN Vacuum Regulator	\$692.00
	9500-0002	OHIO Vacuum Regulator	\$692.00
	9500-0003	CHEMETRON Vacuum Regulator	\$692.00
	9500-0004	OXEQUIP Vacuum Regulator	\$692.00
	9500-0011	Replacement Canisters Six 1500ml Single-Use Canisters	\$112.00
	9500-0000-0003	Canister Holder	\$60.00
	9500-0000-0004	Wall Plate	\$86.00
	8900-0000-0002	Clear Vacuum Tube 6'	\$52.00

ORAL SURGERY NITROGEN MANIFOLD SYSTEMS

2 Nitrogen Cylinders System.....\$3,348.00

N100 Includes:
Manifold, Regulators, Hoses,
Tank Restraints



3 Nitrogen Cylinders System.....\$3,924.00

N150 Includes:
Manifold, Regulators, Hoses,
Tank Restraints



NITROGEN MANIFOLD COMPONENTS



4500 Nitrogen Manifold • 2 Cylinders \$1,846.00

4501 Nitrogen Manifold • 3 Cylinders \$2,020.00



4022-0000-0050 Tank Restraint
Holds two G/H-Size Cylinders \$140.00

NITROGEN OUTLET STATIONS • DISS



9010-0004 Nitrogen DISS Outlet • Concealed \$422.00





9000-0004 Nitrogen DISS Outlet • Exposed \$480.00

ORAL SURGERY



QUICK CONNECTORS FOR SURGICAL HAND PIECES

	4552	Stryker Drill Adapter Nitrogen DISS Hand-Tight Nut X Eastman Quick Connect 90°	\$274.00
	4550	Hall Drill Adapter Nitrogen DISS Hand-Tight Nut X Schrader Coupler 90°	\$274.00
	4553	Adjustable Pressure Regulator • Stryker 0-150psi with Gauge	\$412.00
	4551	Adjustable Pressure Regulator • Hall 0-150psi with Gauge	\$412.00

OXYGEN FLOWMETER – RECOVERY ROOM

	9700-0001	Puritan Quick Connect Oxygen Therapy Flowmeter 0-15LPM	\$196.00
	9700-0002	Ohio Quick Connect Oxygen Therapy Flowmeter 0-15LPM	\$196.00
	9700-0003	Chemetron Quick Connect Oxygen Therapy Flowmeter 0-15LPM	\$196.00
	9700-0004	Belmed PC7 Oxygen Therapy Flowmeter 0-15LPM	\$196.00
	9700-0005	Belmed PC7-C/Porter Quick Connect Oxygen Therapy Flowmeter 0-15LPM	\$196.00
	9700-0006	Hand-Tight DISS Oxygen Therapy Flowmeter 0-15LPM	\$196.00
	9700-0000-0011	High Concentration Mask w/Breathing Bag *Connects to Therapy Flowmeter with 7' tubing	\$15.00

CANNULA ADAPTER

	9700-0021	Cannula Adapter	\$98.00
	9700-0000-0031	Nasal Cannula • 50/Box	\$168.00

REGULATORS

SINGLE HIGH PRESSURE GAUGE • 50PSI PRE-SET



4900-0000-0001

Oxygen

\$506.00



4900-0000-0002

Nitrous Oxide

\$506.00

TWO GAUGE ADJUSTABLE PRESSURE



4900-0000-0013

Nitrogen

\$530.00



4900-0000-0011

Oxygen

\$530.00



4900-0000-0012

Nitrous Oxide

\$530.00

YOKE STYLE REGULATORS



4900-0000-0021

Single High Pressure Gauge
50psi Pre-Set

\$518.00



4900-0000-0022

Two Gauge Adjustable
Liter Flow 0-15LPM

\$498.00

FITTINGS



	Male 1/8 NPT X Male DISS		
6002-0000-0004	O2	\$46.00	
6002-0000-1001	N2O	\$46.00	
6002-0000-2013	VAC	\$46.00	



	Male 1/4 NPT X Male DISS		
6002-0000-0001	O2	\$46.00	
6002-0000-1003	N2O	\$46.00	
6002-0000-2014	VAC	\$46.00	



	1/4 Hose Barb X Female DISS		
8000-0000-0008	O2	\$46.00	
8100-0000-0007	N2O	\$46.00	
8200-0000-0007	VAC	\$46.00	



	Pressure Activated Check Valve Male 1/8 NPT X Male DISS		
6002-0000-0003	O2	\$58.00	
6002-0000-1016	N2O	\$58.00	



	Pressure Activated Check Valve Male 1/4 NPT X Male DISS		
6002-0000-0020	O2	\$58.00	
6002-0000-1002	N2O	\$58.00	



	Hose Activated Check Valve Male 1/8 NPT X Male DISS		
6002-0000-0021	O2	\$58.00	
6002-0000-1017	N2O	\$58.00	



	Hose Activated Check Valve Male 1/4 NPT X Male DISS		
6002-0000-0022	O2	\$58.00	
6002-0000-1018	N2O	\$58.00	



	1/4 Hose Barb X Female 1/8 NPT		
6004-0000-0005		\$58.00	



	1/4 Hose Barb X Female 1/4 NPT		
6004-0000-0014		\$58.00	



	1/4 Hose Barb X Male 1/8 NPT		
6004-0000-0002		\$58.00	



	1/4 Hose Barb X Male 1/4 NPT		
6004-0000-0011		\$58.00	



	Elbow • Female 1/8 NPT X Female 1/8 NPT (90°)		
6004-0000-0010		\$36.00	



	Elbow • Female 1/4 NPT X Female 1/4 NPT (90°)		
6004-0000-0007		\$36.00	



	Elbow • Male 1/8 NPT X Female 1/8 NPT (90°)		
6004-0000-0015		\$36.00	



	Elbow • Male 1/4 NPT X Female 1/4 NPT (90°)		
6004-0000-0009		\$36.00	



	Tee • Female 1/8 NPT		
6004-0000-0016		\$36.00	



	Tee • Female 1/4 NPT		
6004-0000-0017		\$36.00	



	Tee • Male 1/8 NPT X Female 1/8 NPT Ends		
6004-0000-0018		\$36.00	



	Tee • Male 1/4 NPT X Female 1/4 NPT Ends		
6004-0000-0019		\$36.00	



	Coupler • Female 1/8 NPT X Female 1/8 NPT		
6004-0000-0020		\$36.00	



	Coupler • Male 1/8 NPT X Male 1/8 NPT		
6004-0000-0021		\$36.00	



	Coupler • Female 1/4 NPT X Female 1/4 NPT		
6004-0000-0022		\$36.00	



	Coupler • Male 1/4 NPT X Male 1/4 NPT		
6004-0000-0023		\$36.00	

FLUSHMOUNT FLOWMETER SYSTEM

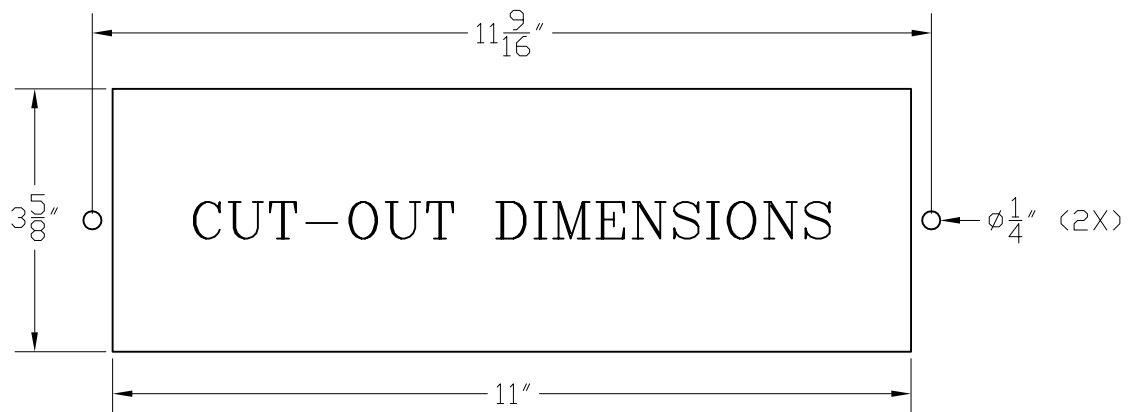
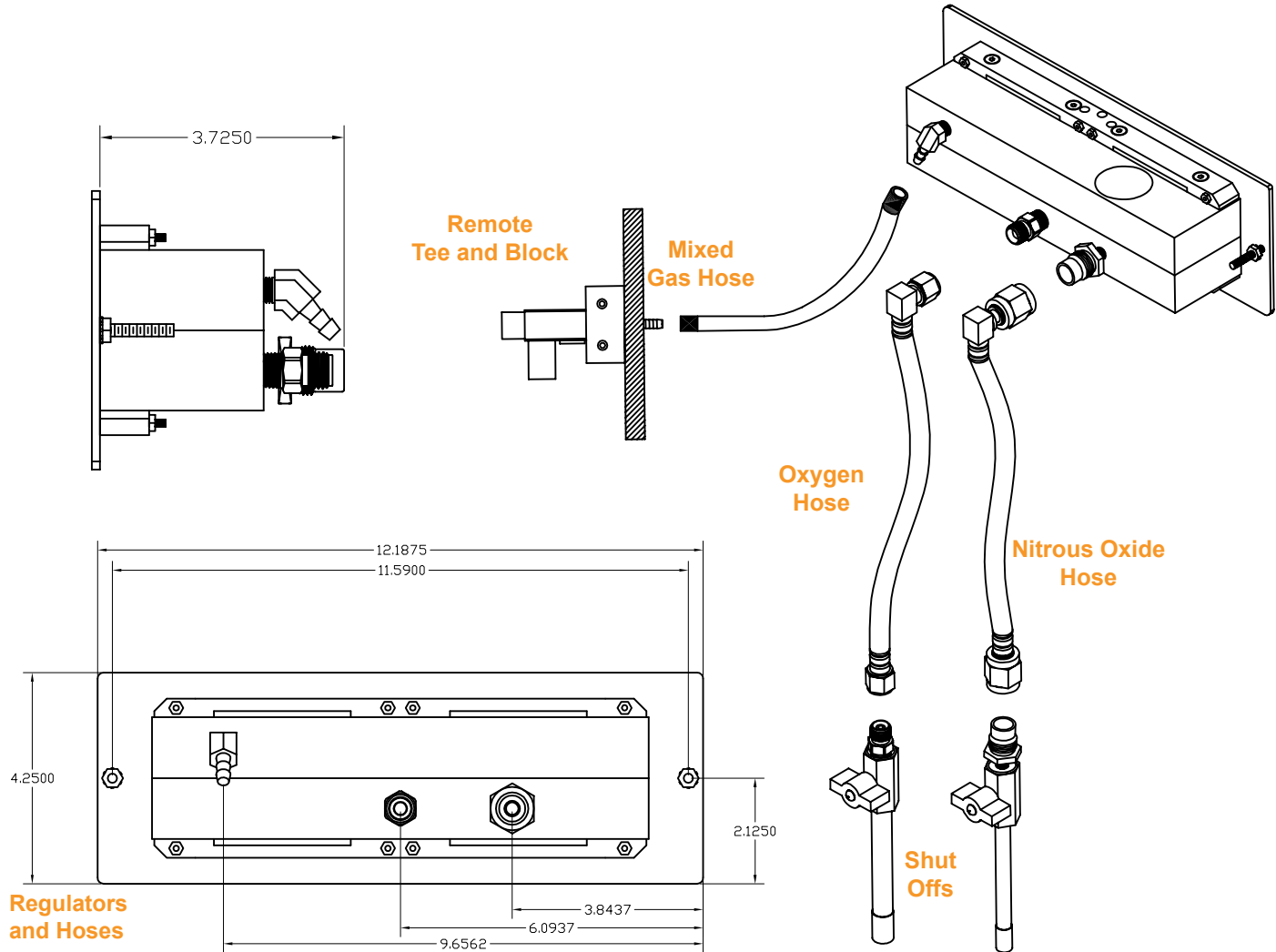

OUTLETS

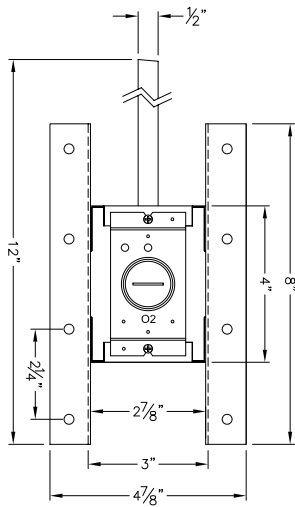

Single Outlet

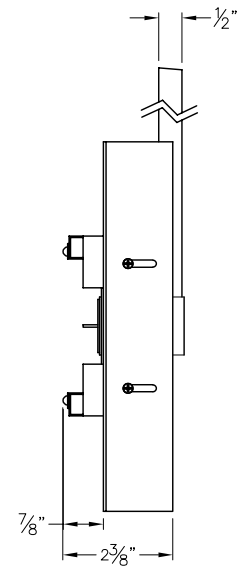

Side View

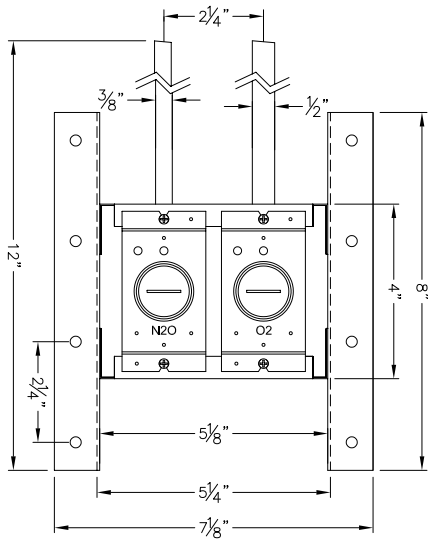

Double Outlet

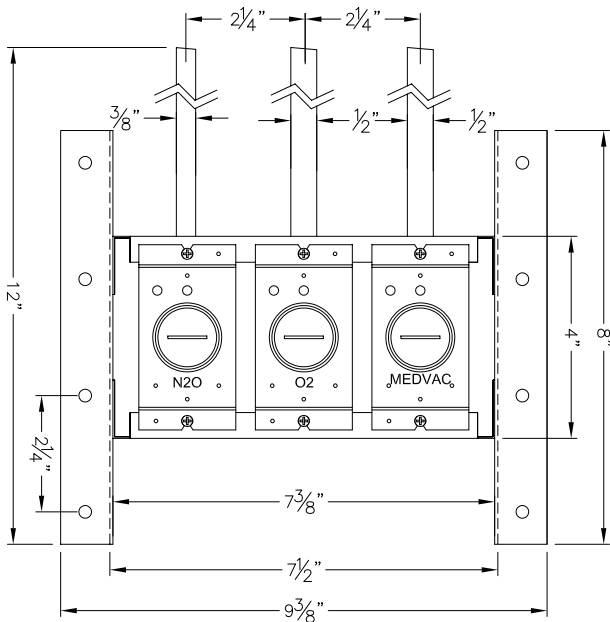

Triple Outlet

Defender AUTOMATIC CHANGEOVER MANIFOLD

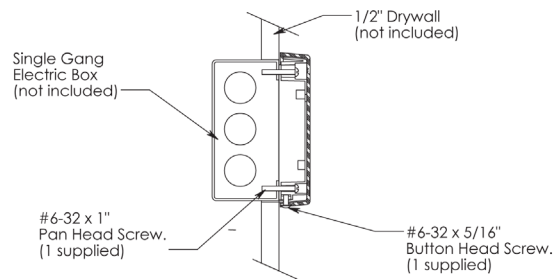
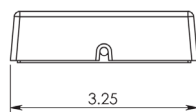
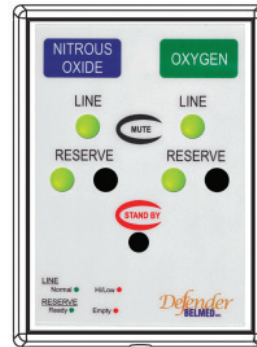
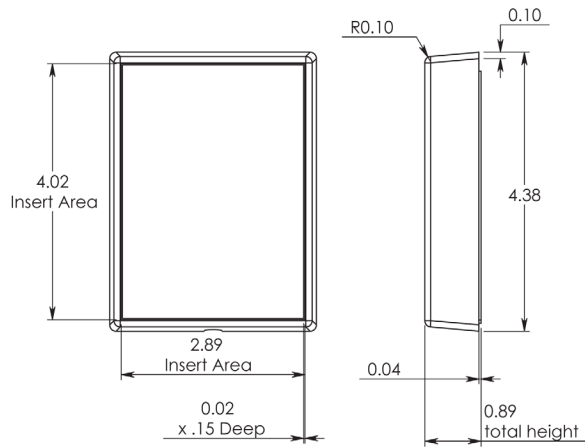
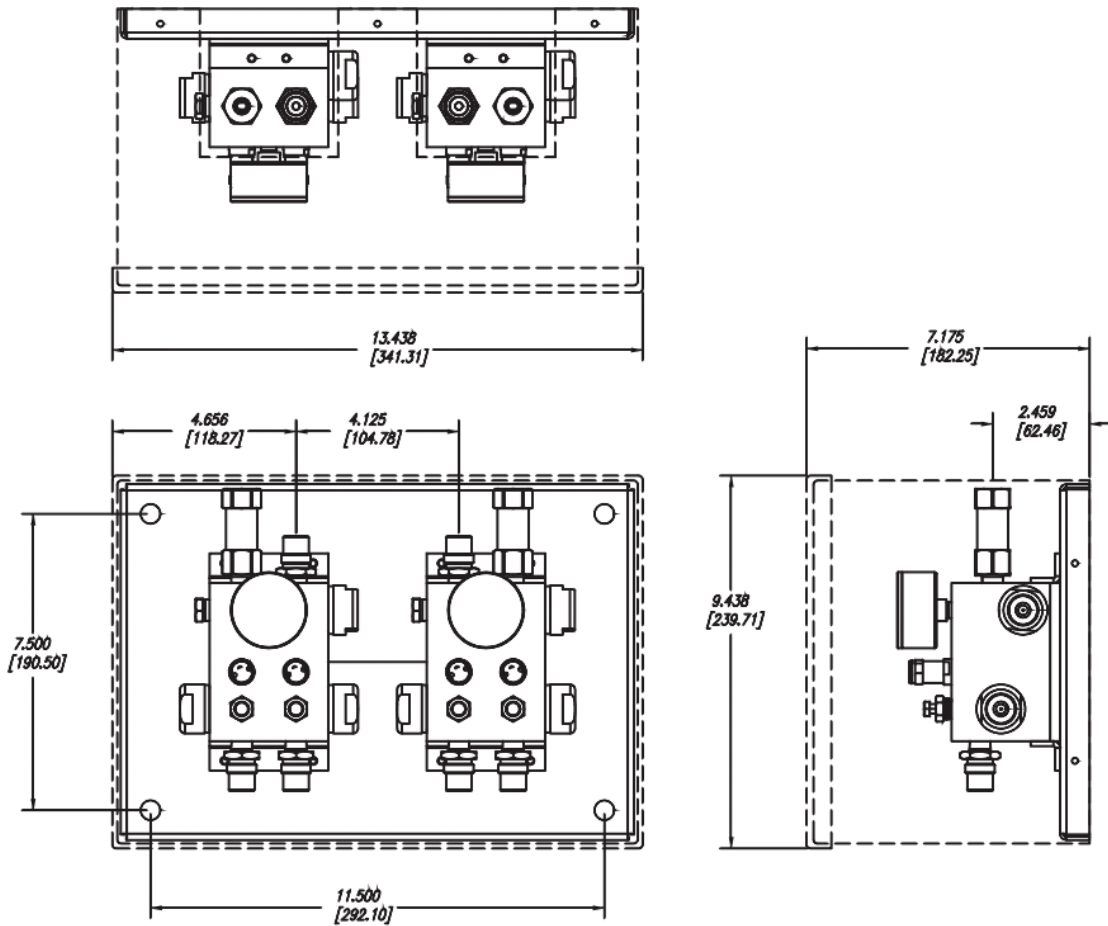

MANUAL MANIFOLD SYSTEM

Manifold Installation Concealed Piping

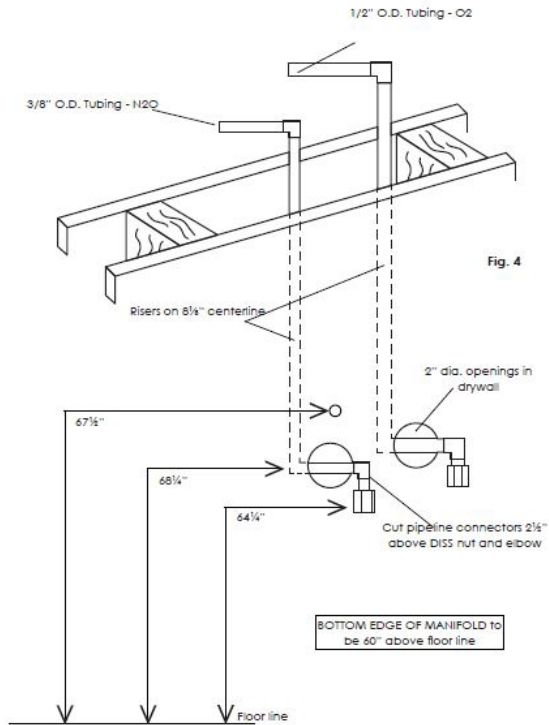

Manifold Installation Exposed Piping

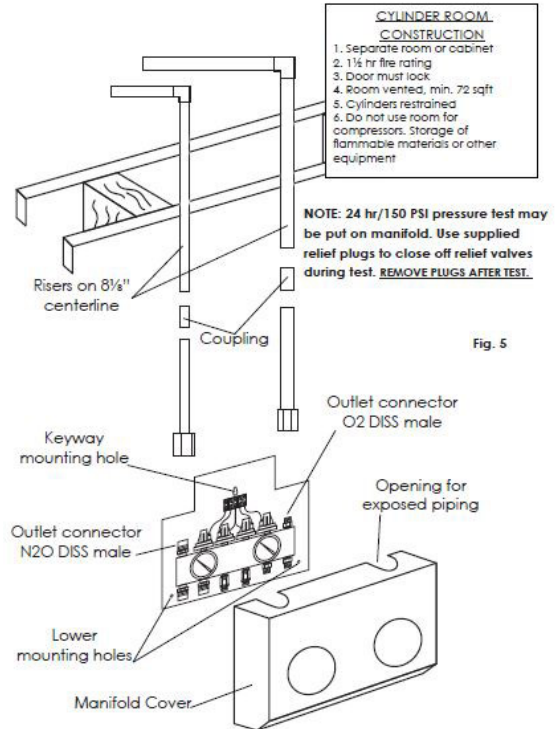

Alarm Installation Wall Alarm

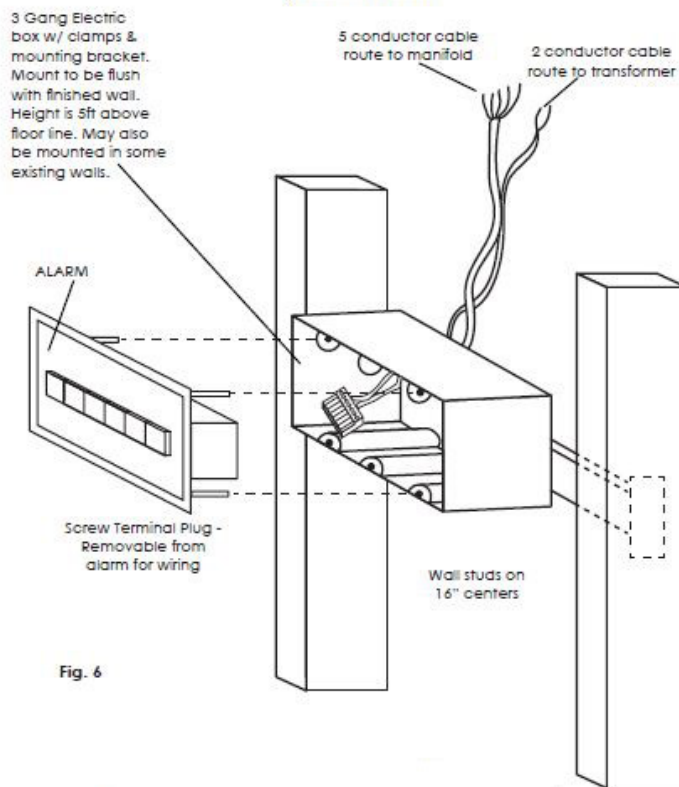

Wiring Connection to Alarm

Terminal is located on rear of alarm. Attach wires from manifold & transformer to proper screw terminals.

- Terminal NOS:
- #1-O2 HI (red)
 - #2-O2 LO (green)
 - #3-COM (black)
 - #4-N2O LO (white)
 - #5-N2O HI (brown)
 - #6 & #7 - Transformer wires

BELMED
 888-723-5893
 www.belmedinc.com

Medical Gas Systems and Equipment

LPM	OXYGEN																			
	0.5	1	1.5	2	2.5	3	3.5	4	4.5	5	5.5	6	6.5	7	7.5	8	8.5	9	9.5	10
0.5	50%	33%	25%	20%	17%	14%	13%	11%	10%	9%	8%	8%	7%	7%	6%	6%	6%	5%	5%	5%
1	67%	50%	40%	33%	29%	25%	22%	20%	18%	17%	15%	14%	13%	13%	12%	11%	11%	10%	10%	9%
1.5	75%	60%	50%	43%	38%	33%	30%	27%	25%	23%	21%	20%	19%	18%	17%	16%	15%	14%	14%	13%
2	80%	67%	57%	50%	44%	40%	36%	33%	31%	29%	27%	25%	24%	22%	21%	20%	19%	18%	17%	17%
2.5	83%	71%	63%	56%	50%	45%	42%	38%	36%	33%	31%	29%	28%	26%	25%	24%	23%	22%	21%	20%
3	86%	75%	67%	60%	55%	50%	46%	43%	40%	38%	35%	33%	32%	30%	29%	27%	26%	25%	24%	23%
3.5	88%	78%	70%	64%	58%	54%	50%	47%	44%	41%	39%	37%	35%	33%	32%	30%	29%	28%	27%	26%
4	89%	80%	73%	67%	62%	57%	53%	50%	47%	44%	42%	40%	38%	36%	35%	33%	32%	31%	30%	29%
4.5	90%	82%	75%	69%	64%	60%	56%	53%	50%	47%	45%	43%	41%	39%	38%	36%	35%	33%	32%	31%
5	91%	83%	77%	71%	67%	63%	59%	56%	53%	50%	48%	45%	43%	42%	40%	38%	37%	36%	34%	33%
5.5	92%	85%	79%	73%	69%	65%	61%	58%	55%	52%	50%	48%	46%	44%	42%	41%	39%	38%	37%	35%
6	92%	86%	80%	75%	71%	67%	63%	60%	57%	55%	52%	50%	48%	46%	44%	43%	41%	40%	39%	38%
6.5	93%	87%	81%	76%	72%	68%	65%	62%	59%	57%	54%	52%	50%	48%	46%	45%	43%	42%	41%	39%
7	93%	88%	82%	78%	74%	70%	67%	64%	61%	58%	56%	54%	52%	50%	48%	47%	45%	44%	42%	41%

*Greater than 70% N2O administered exceeds the amount able to be delivered by sedation machine.

POLICIES

Terms: Net 30 Days. Accounts over 30 days past due will be placed on credit hold.
Prices: All prices are F.O.B. Red Lion, PA, and subject to change without notice.

WARRANTY

Definition of a Warranty Return: A product or part covered by the Belmed Inc. warranty that fails while the terms of the warranty are in effect.

THIS WARRANTY IS GIVEN IN PLACE OF ALL OTHER WARRANTIES, EXPRESS OR IMPLIED, OF MERCHANTABILITY, FITNESS FOR A PARTICULAR PURPOSE, OR OTHERWISE.

No statement or claim about the product by any employee, agent, representative, or dealer of Belmed Inc. shall constitute a warranty by Belmed Inc. or give rise to any liability or obligation of Belmed Inc.

Subject to the next sentence, Belmed Inc. warrants that each product or part shall be free from defects in workmanship and materials—under normal use and with appropriate maintenance—for one (1) year from the date of delivery to customer. For plastic, rubber, and disposable parts or items, Belmed Inc. warrants only that each such part and item shall be free from defects in workmanship and materials at the time of delivery to the customer.

Belmed Inc.'s obligation for breach of this warranty, or for negligence or otherwise, shall be strictly and exclusively limited to Belmed Inc.'s choice of repair or replacement of the product or part. ***This warranty shall be void for any product on which the serial number has been altered, defaced, or removed.***

Belmed Inc. shall not be liable for any damage, injury, or loss arising out of the use of the product, whether as a result of a defect in the product or otherwise, if prior to such damage, injury, or loss, the product was (1) damaged, misused, or misapplied; (2) repaired, altered, or modified by persons other than Belmed Inc.; (3) not installed in strict compliance with applicable codes and ordinances; or (4) not installed by Belmed Inc. or an authorized Belmed Inc. dealer.

UNDER NO CIRCUMSTANCES SHALL BELMED INC. BE LIABLE FOR INCIDENTAL OR CONSEQUENTIAL DAMAGES AS THOSE TERMS ARE DEFINED IN THE UNIFORM COMMERCIAL CODE.

Equipment Repair • Repair Procedures:

Belmed Inc. offers evaluation and repair service on all Belmed Inc. products. We provide excellent turnaround on all products with customer approval for service-repair work. Initial \$40.00 inspection fee will be charged. Products returned for repair will be accepted without a return authorization number. Specify that it is an item for repair and marked to the attention of the Repair Service Center.

Returning Goods:

1. The following will NOT be accepted for credit:
 - Rubber goods over 30 days old
 - Rubber goods not in original, sealed package
 - All custom or opened hoses
 - Special order items
 - Goods without a Return Goods Authorization (RA)
 - Merchandise more than 90 days old (from Belmed Inc. invoice date)
2. A 20% restocking charge will be deducted from the original purchase amount for all credits issued. A 30% restocking fee will be deducted from all major equipment orders, except for return due to:
 - Belmed Inc. order entry error
 - Warranty returns
3. There is a minimum restocking charge of \$10.00.
4. Return Goods Authorization (RA) numbers are valid for 30 days after the date issued.
5. Freight charges will not be credited.
6. Freight collect shipments are not accepted.
7. If merchandise is found to have been misused or in any way damaged after shipment from Belmed Inc., credit will be made less charges for repair and less the 20% restocking charge. If merchandise is not salvageable, no credit will be issued.
8. All claims for damage or shortage occurring in transit must be made by the customer directly to the carrier.

Warranty Returns:

1. Merchandise returned for warranty credit or replacement must have been purchased from Belmed Inc. within the specified warranty period or proof of installation within that time will be required.
2. Defective items will, at Belmed Inc.'s discretion, either be repaired or replaced with equivalent merchandise.
3. If merchandise is found to not be defective the 20% restocking fee will be charged.
4. Freight charges to return defective merchandise to Belmed Inc. are not reimbursable.
5. Freight charges to ship replacement or repaired merchandise to customer will be paid by Belmed Inc.

Customer Instructions:

Please follow the procedures outlined below so there is no delay of credit to your account.

You must have a Return Goods Authorization (RA) number before returning any merchandise to Belmed Inc.—except for out-of-warranty repairs for servicing. Credit may be issued only after the merchandise is returned to and inspected by Belmed Inc. and determination is made that credit is due.

To Receive a Return Authorization:

1. Call your Belmed Inc. Customer Service Representative.
2. Be prepared to provide the following information:
 - a. Our invoice number and date.
 - b. Product description, product number, and serial number (if applicable).
 - c. Reason you wish to return the merchandise.
3. Your Customer Service Representative will give you an RA number. A separate RA number will be provided for each Belmed Inc. invoice reference. The RA number authorizes our receiving department to accept the merchandise.
4. Enclose a copy of our original invoice.
5. Send the merchandise freight pre-paid.

Shortages:

Any shortages or discrepancies with orders must be reported to Belmed Inc. within 30 days ARO.

888.723.5893 • www.belmedinc.com

Order:

orders@belmedinc.com

Fax: 717.246.7586

Mail to:

PO Box 247

Red Lion, PA 17356-0247

Ship to:

887 Delta Rd.

Red Lion, PA 17356-0247

Contact Us:

717.246.5500

Fax: 717.246.7586

bmi@belmedinc.com

Tech Support:

help@belmedinc.com